

COMPASS

Comparative Packaging Assessment

Minal T. Mistry

BizNGO webinar - 12 April 2013

agenda

- Intro
- Background
- COMPASS model
- Data
- Streamlined LCA
- Material health
- Discussion / Q&A

leveraging the design process

the whole system perspective

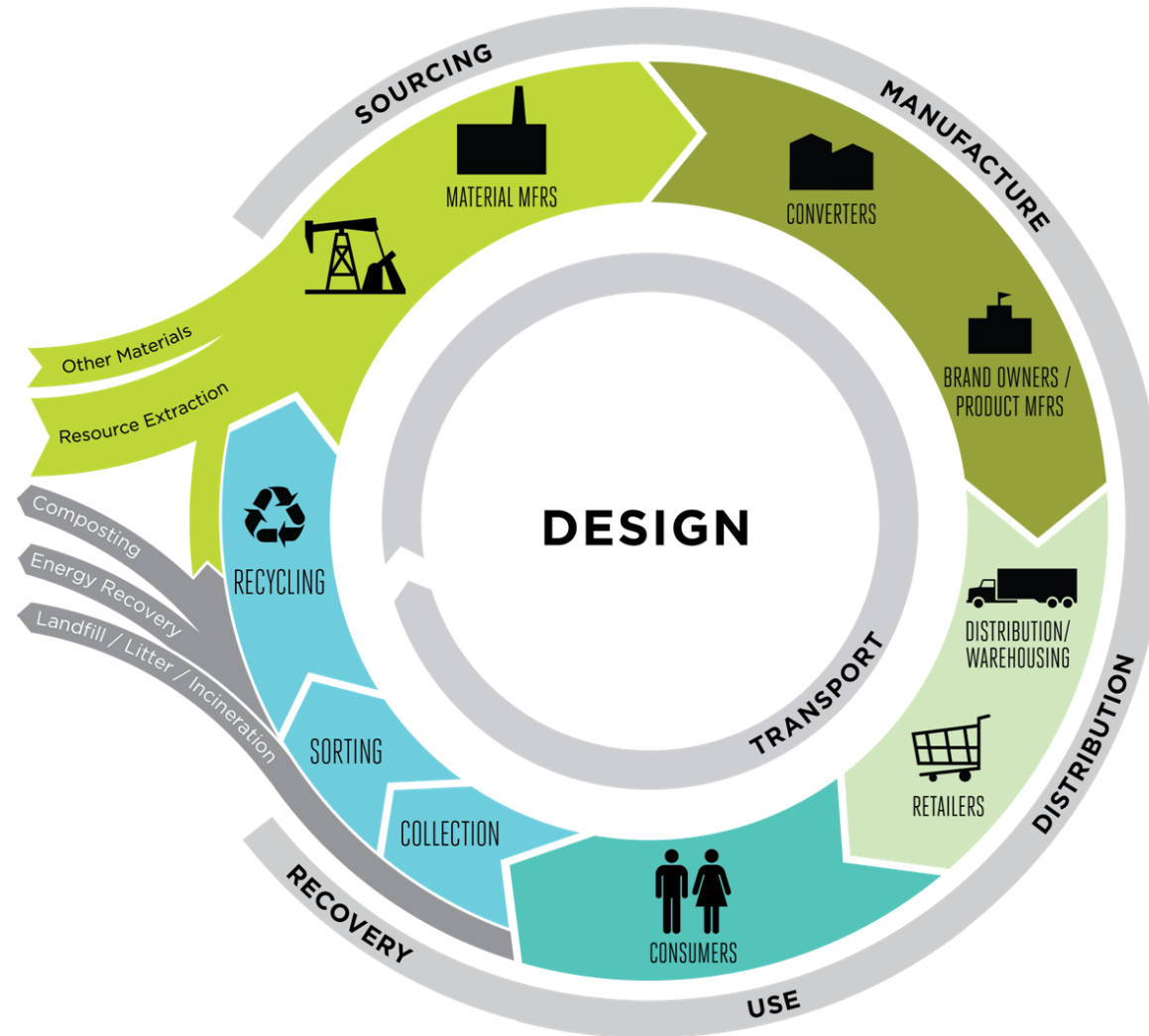

**SUSTAINABLE PACKAGING
COALITION®**

A PROJECT OF GREENBLUE™

COMPASS



implications of design choices

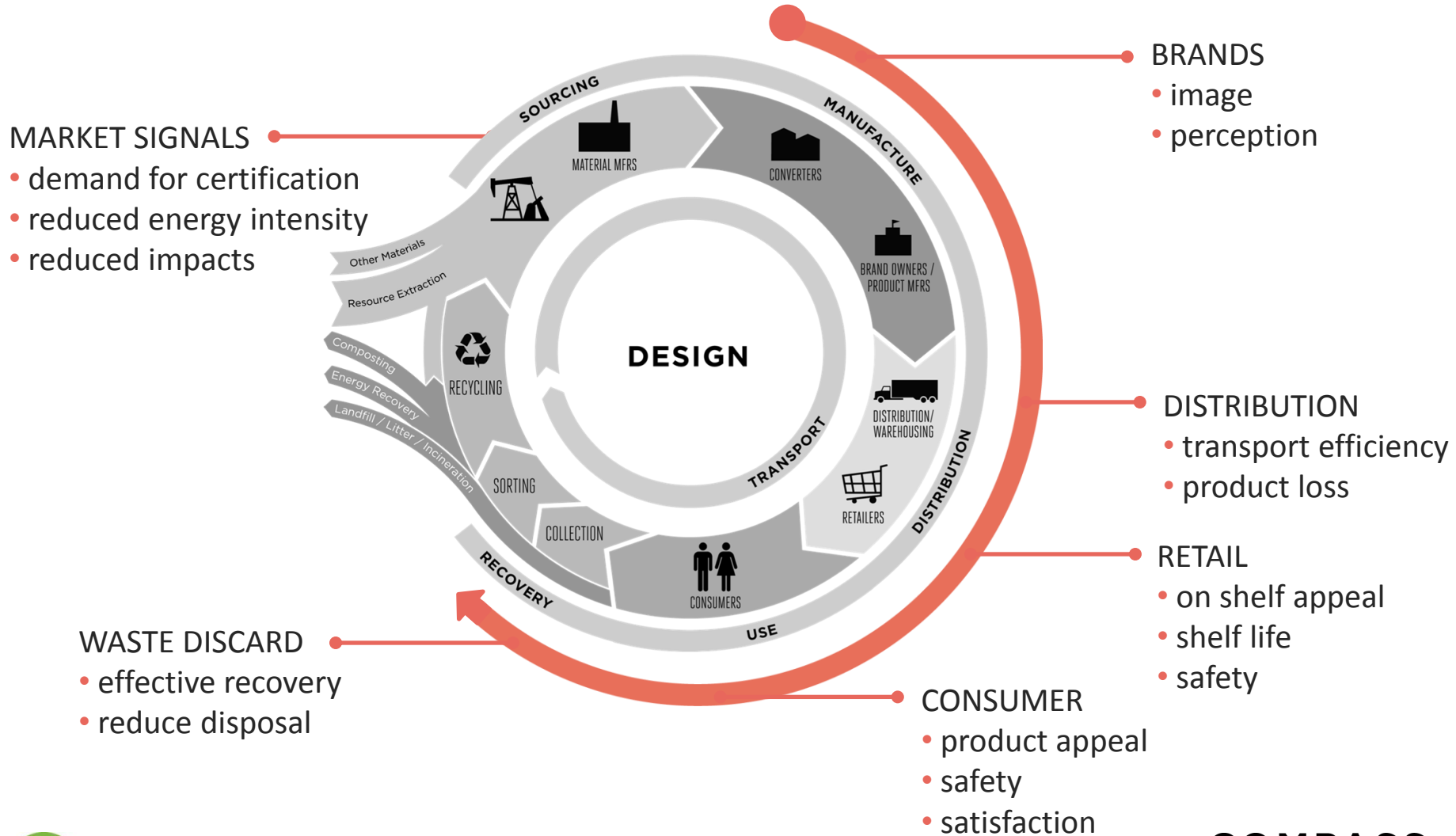

the model

COMPASS



a **design-phase** web application that provides
comparative **environmental profiles** of **packaging** alternatives
based on **life cycle** assessment **metrics** and **attributes**

build scenarios using components



SIMPLE COMPONENTS

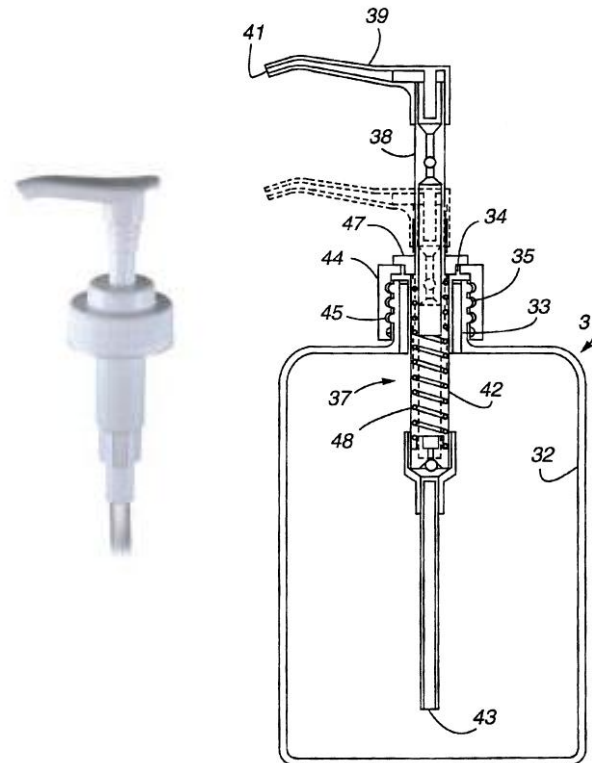

COMPOSITE COMPONENTS

packaging system

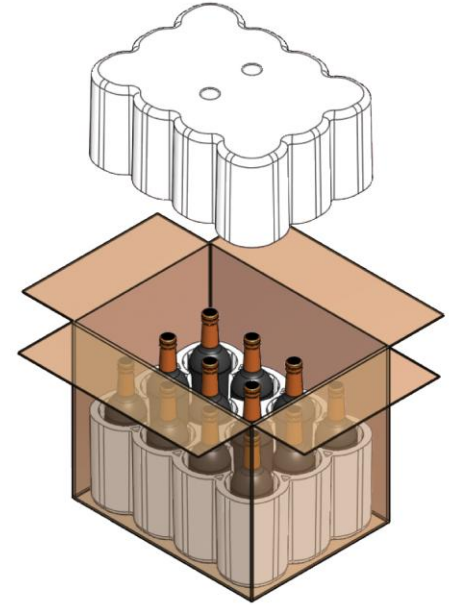

PRIMARY PACKAGE



SECONDARY PACKAGE



PACKAGING SYSTEM



**SUSTAINABLE PACKAGING
COALITION®**

A PROJECT OF  GREENBLUE™

COMPASS

 GREENBLUE™

multi-pack scenario

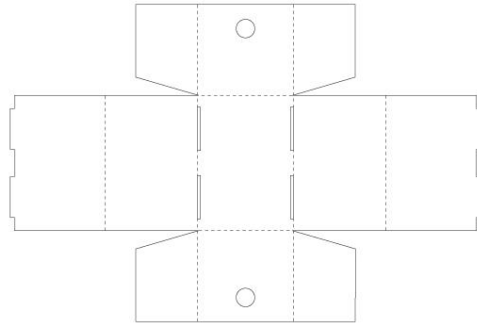

COMPONENT A x 6

- Bottle
- Label
- Cap

COMPONENT B x 1

- Carry case

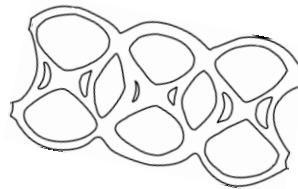

COMPONENT A x 6

- Can

COMPONENT B x 1

- six-pack rings



**SUSTAINABLE PACKAGING
COALITION®**

A PROJECT OF  GREENBLUE™

COMPASS

 GREENBLUE™

refill scenario

APPLICATIONS: liquid soap, cosmetics, wipes and cleansers, etc.

Waste Reduction Model

The entire package is reused and is refilled from another package (forms and capacity can vary).



CRITICAL COMPONENT

Extended Life Model

A critical component(s) is reused while the rest of the components are discarded and replaced with a refill package.



Refill scenarios requiring washing or industrial cleaning are excluded.

account for distribution legs

MODE	VEHICLE	DISTANCE: km and m
Road	- relevant trucks to the region	FUEL: diesel, gasoline, kerosene , other as available
Rail	- freight train	DATA: USLCI and ecoinvent
Sea	- barge and transoceanic freight ship	
Air	- cargo plane	

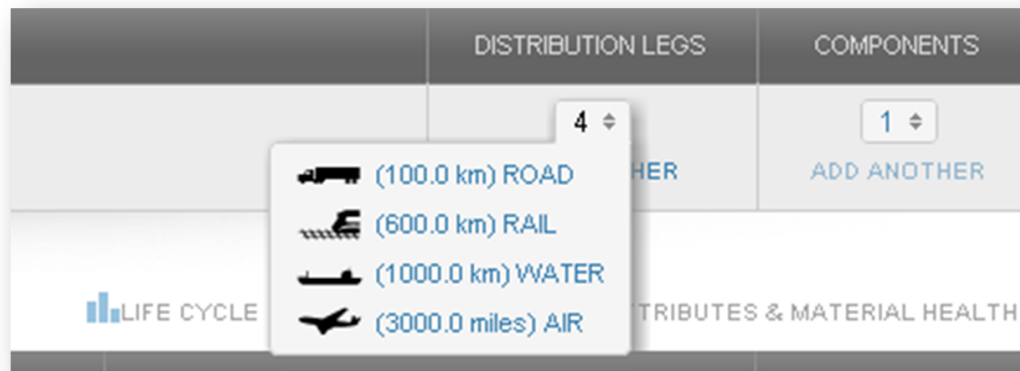

life cycle coverage in COMPASS

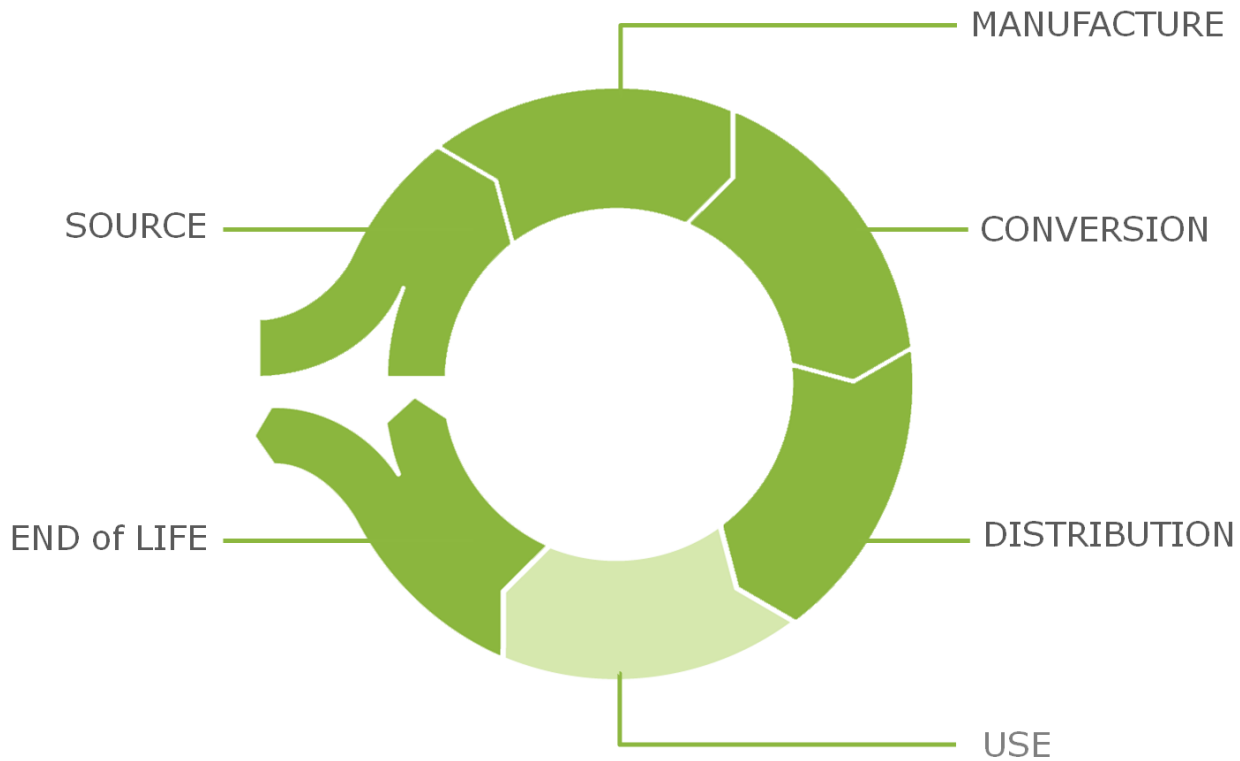

transport model (being developed)

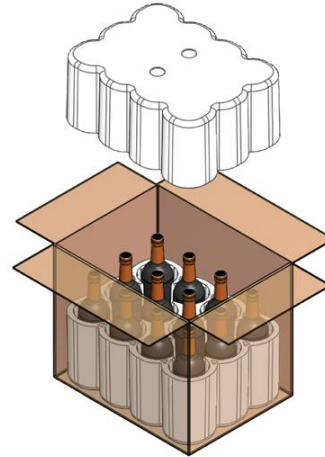

PRIMARY
PACKAGE

SECONDARY
PACKAGE

PACKAGING
SYSTEM

TRANSPORT
PACKAGE



Add distribution related transport for components, packages and shipping the system to the DC

DATA

data

- Consistent background data modeling for common packaging materials and processes
- Apples to apples comparisons based on common functional unit
- Region specific solid waste profiles for US, CA, EU
- Verified by industry and external reviewers

data sets

- Data sets for U.S., Canada, Europe
 - Background data from ecoinvent and USLCI
- End of Life (EoL) treatments for packaging
 - Landfill, WtE, compost, incineration, litter
- EoL solid waste profile
 - Regional recover and discard information from USEPA, EuroStat, StewardEdge Canada

materials and processes

- Polymers
 - HDPE, LDPE, LLDPE, PET, PP, PS, EPS, PVC, PVDC, PLA, EVA, Nylon 6, PC, Modified starch (Mater-bi)
 - PU, SAN, ABS
 - Fibers
 - Solid Bleached and unbleached Sulfate Board (SBS and SUS), Recycled Folding Boxboard, Corrugated, Supercalendered Paper, Bleached and Unbleached Kraft Paper, Liquid Packaging Board
 - Jute, Kenaff, Cotton (coming soon)
 - Metals
 - Steel, stainless steel and aluminum
 - Container glass
- Polymers
 - Blow molding
 - Extrusion, plastic film
 - Foaming, expanding
 - Injection molding
 - Stretch blow molding
 - Thermoforming, with calendaring
 - Fibers
 - Production of paper bags
 - Production of carton
 - Production of corrugated boxes
 - Cutting
 - Weaving (coming soon)
 - Metals
 - Sheet rolling
 - Production of steel can

informed prototyping

comparative packaging assessment



COMPASS[®] (comparative packaging assessment)

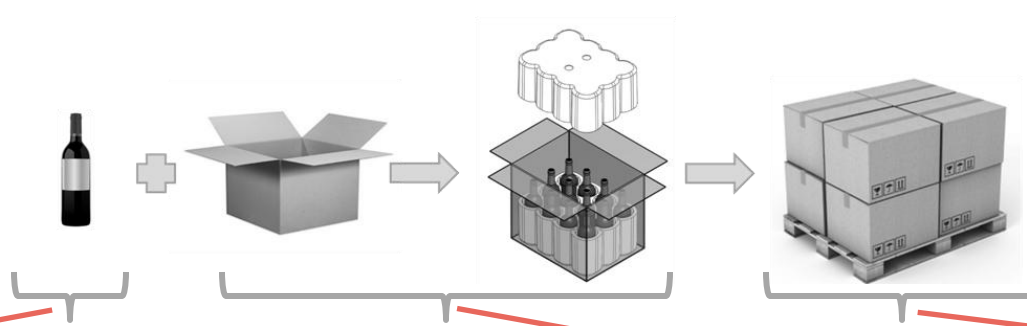

component level assessment during the concept and prototype stages to optimize the system

component in relation to package

PRIMARY PACKAGE OVERVIEW:
SOAP IN A PUMP DISPENSER + REFILL POUCH

EXPORT DELETE PACKAGE

NAME
 Soap in a Pump dispenser + refill pouch

DESCRIPTION
 Primary package: PET bottle and pump assembly, composite pouch with 4x volume. Compared to five units of the pump dispenser.

TOTAL CAPACITY 1,250 ml

DATA SET US

DISTRIBUTION LEGS + ADD + LIST

UPDATE

COMPONENT CONTRIBUTION

The chart displays the percentage contribution of each component to the total environmental impact across eight categories. The components are color-coded: Bottle (red), Cap (purple), Pouch (green), and Pump assembly (blue). The Y-axis ranges from 0% to 100%.

COMPONENT DETAILS + NEW + ADD EXISTING COMPONENT

NAME	MATERIAL AND CONVERSION	% PCR	% CERT.	DISTRIBUTION LEGS	COMPONENTS
■ Bottle EDIT COPY DELETE	50.0 g of Polyethylene Terephthalate (PET) converted using Injection Molding	0.0	0.0	(None Yet) ADD FIRST	(None Yet) ADD FIRST
■ Cap EDIT COPY DELETE	7.0 g of Polystyrene (PS) converted using Injection Molding	0.0	0.0	(None Yet) ADD FIRST	(None Yet) ADD FIRST
■ Pouch EDIT COPY DELETE	Composite (total weight: 32.5 grams)	0.0	0.0	(None Yet) ADD FIRST	2 + ADD ANOTHER
■ Pump assembly EDIT COPY DELETE	Composite (total weight: 10.0 grams)	3.5	0.0	(None Yet) ADD FIRST	4 + ADD ANOTHER

package to package comparison

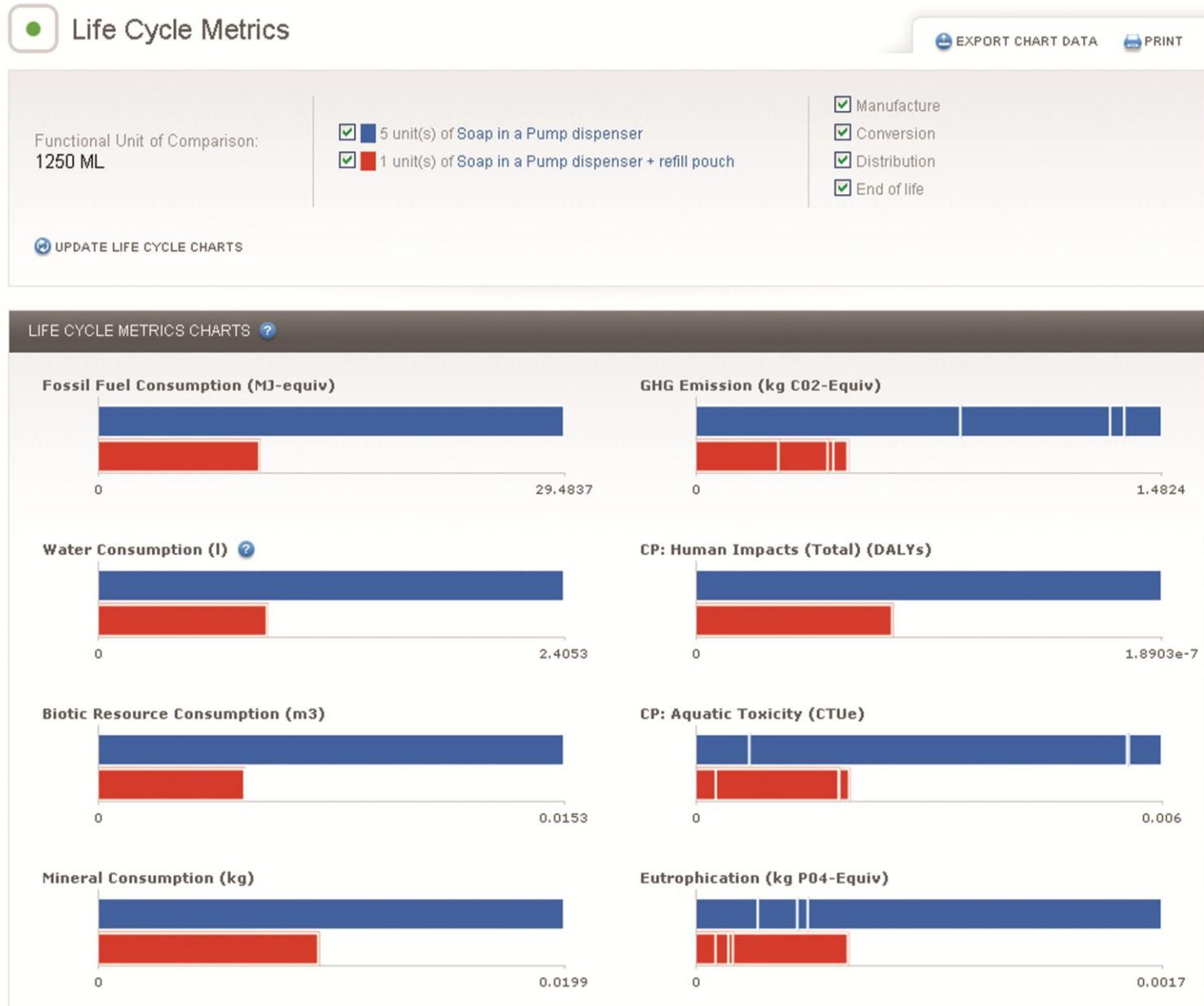

attributes and material health

Packaging Attributes & Material Health

EXPORT CHART DATA

PRINT

Functional Unit of Comparison:
1250 ML

5 unit(s) of Soap in a Pump dispenser

1 unit(s) of Soap in a Pump dispenser + refill pouch

UPDATE PACKAGING ATTRIBUTES CHARTS

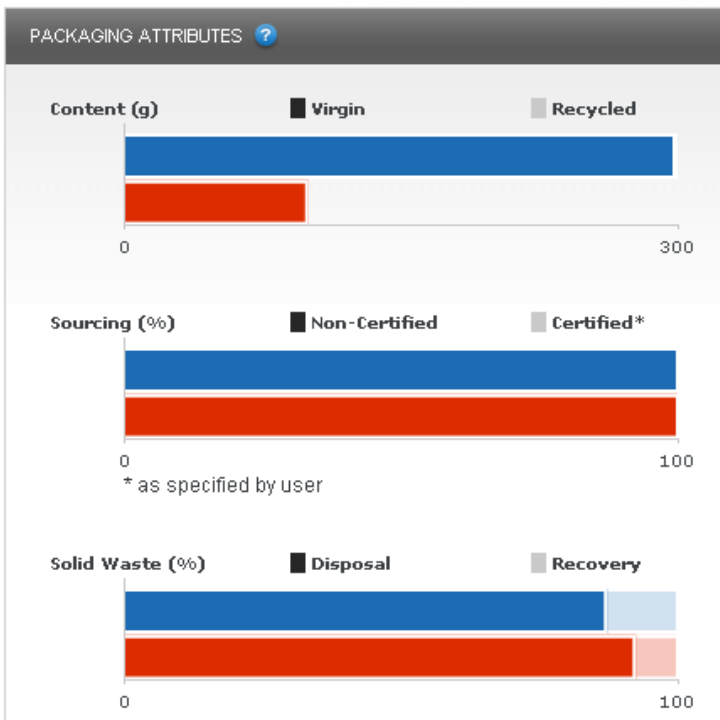

MATERIAL HEALTH ?

Material Health	Weight	C	R	PBT
5.0 unit(s) of Soap in a Pump dispenser	300.00g	8	1	0
1.0 unit(s) of Soap in a Pump dispenser + refill pouch	99.50g	11	1	0
Bottle	50.00g	3	1	0
Cap	7.00g	2	0	0
Pouch	32.50g	1	0	0
Pump assembly	10.00g	5	0	0
Pump top	4.00g	2	0	0
Spring assembly	2.00g	1	0	0
Polypropylene (PP)	3.00g	1	0	0
High-Density Polyethylene (HDPE)	1.00g	1	0	0
Heavy fuel oil <i>Burned in industrial furnace; not present in final material</i>	0.01g	1	0	0

C: Carcinogen

R: Reproductive Toxicant

PBT: Persistent, Bioaccumulative, and Toxic

material health

MATERIAL IQ



A business to business online registry that provides sustainability information about materials used in a variety of product and industrial sectors.

Material profiles for product intelligence

Pellentesque habitant morbi tristique senectus et netus et malesuada fames ac turpis egestas. Vestibulum tortor quam, feugiat vitae, ultricies eget, tempor sit amet, ante. Donec eu libero sit amet quam egestas semper. Aenean ultricies mi vitae est. Mauris placerat eleifend leo.

Subscribe

Learn More



Tools for Transparency



Pellentesque habitant morbi tristique senectus et netus et malesuada fames ac turpis egestas. Vestibulum tortor quam, feugiat vitae, ultricies eget, tempor sit amet, ante. Donec eu libero sit amet quam egestas semper.

Profiles in Sustainability



Nike →

Pellentesque habitant morbi tristique senectus et netus et malesuada fames ac turpis egestas. Vestibulum tortor quam.

Vestibulum erat wisi

Pellentesque habitant morbi tristique senectus et netus et malesuada fames ac turpis egestas. Vestibulum tortor quam, feugiat vitae, ultricies eget, tempor sit amet, ante. Donec eu libero sit amet quam egestas semper. Aenean ultricies mi vitae est. Mauris placerat eleifend leo. Quisque sit amet est et sapien ullamcorper pharetra.

[Polymer](#) »

TUB 121 Polyethylene Copolymer

INEOS Olefins & Polymers USA

Pellentesque habitant morbi tristique senectus et netus et malesuada fames ac turpis egestas. Vestibulum tortor quam, feugiat vitae, ultricies eget, tempor sit amet, ante. Donec eu libero sit amet quam egestas semper. Aenean ultricies mi vitae est. Mauris placerat eleifend leo.

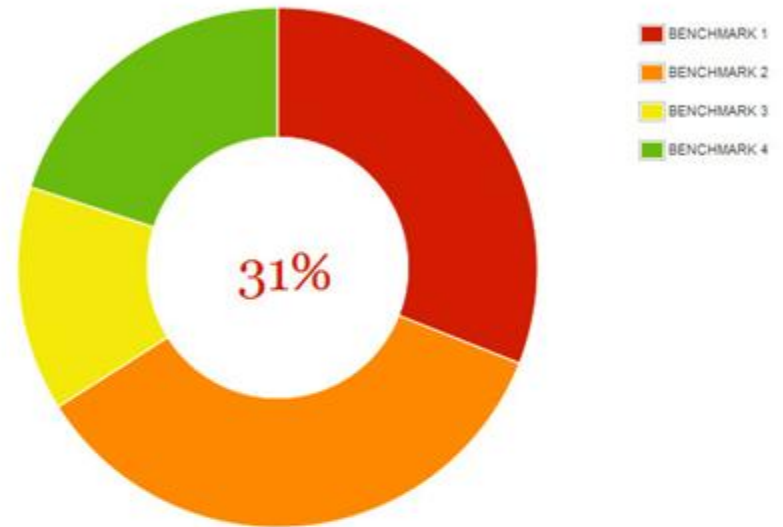

Continuous Improvement Index



Benchmark 1 Chemicals

Chemical	CAS #	%
Ethylene-Hexene-1 Copolymer (pure)	25213-02-9	25.00%
Carbon Black	1333-86-4	4.00%
Proprietary #2		1.00%
Anti-oxidant		1.00%

Ecolabels

Standards		Ecolabels		Banned/Restricted Substances	
				Regulatory	Voluntary
LEED	BIFMA	ECOLOGO	NIKE SUS. INDEX	ROHS 1 & 2	GOOGLE RED LIST

material health summary view

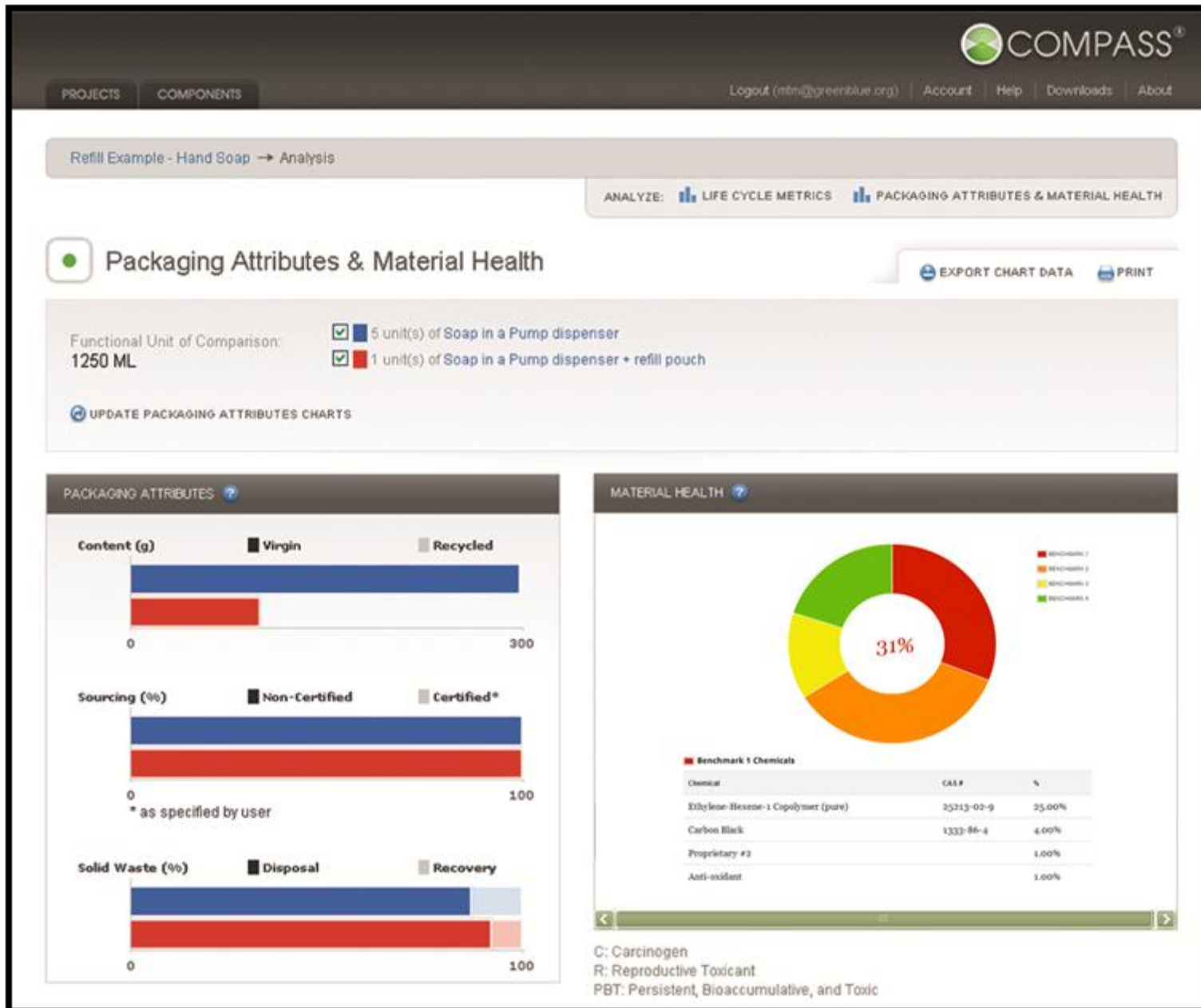

material health detailed view

PROJECTS
COMPONENTS



Logout (mfn@greenblue.org)
Account
Help
Downloads
About

Refill Example - Hand Soap → Analysis

ANALYZE:
 LIFE CYCLE METRICS
 PACKAGING ATTRIBUTES & MATERIAL HEALTH

●

Packaging Attributes & Material Health

EXPORT CHART DATA
 PRINT

Functional Unit of Comparison: **1250 ML**

5 unit(s) of Soap in a Pump dispenser

1 unit(s) of Soap in a Pump dispenser + refill pouch

[UPDATE PACKAGING ATTRIBUTES CHARTS](#)

PACKAGING ATTRIBUTES ?

Content (g)

■ Virgin ■ Recycled

0 300

Sourcing (%)

■ Non-Certified ■ Certified*

0 100

* as specified by user

Solid Waste (%)

■ Disposal ■ Recovery

0 100

MATERIAL HEALTH ?

Expanded Material Profile

Chemical	CAS#	%	Hazard	Human Health Effects										EcoTox	PBT	P-Clean	
				C	R	PBT	1	2	3	4	5	6	7				8
Ethylene-Bisoxane-1 Copolymer	25123-00-9	<15	1	■	■	■	■	■	■	■	■	■	■	■	■	■	■
Polyethylene-Bisoxane Copolymer	25187-34-7	<15	1	■	■	■	■	■	■	■	■	■	■	■	■	■	■
Carbon Black	1332-86-4	<1	1	■	■	■	■	■	■	■	■	■	■	■	■	■	■
Propylparaben #1		<1	3	■	■	■	■	■	■	■	■	■	■	■	■	■	■
Propylparaben #2		<1	4	■	■	■	■	■	■	■	■	■	■	■	■	■	■
UV stabilizer	7832-00-7	<1	4	■	■	■	■	■	■	■	■	■	■	■	■	■	■
Anti-rust agent	1025-13-963	<1	4	■	■	■	■	■	■	■	■	■	■	■	■	■	■
Flame retardant	848-38-86	<1	4	■	■	■	■	■	■	■	■	■	■	■	■	■	■

Key Sustainability Indicators

Item	Value	Target	Completion
\$3 Recycled Content	Non-Compliant	10%	Technical Data Sheet
# Recycled-by-weight	Non-Compliant	10%	Material Safety Sheet
\$3 Recycled Content	Compliant	10%	Regulatory Compliance
\$3 Recycled Content	Compliant	10%	Carbon Offset
\$3 Recycled Content	Compliant	10%	WCA
\$3 Recycled Content	Compliant	10%	EPDs

C: Carcinogen
 R: Reproductive Toxicant
 PBT: Persistent, Bioaccumulative, and Toxic

next generation tools

- **COMPASS + ArtiosCAD**
 - Combine rapid virtual prototyping with environmental profile based on BOM
 - Baseline and track environmental changes performance over
- **COMPASS + CAPE**
 - Combine cube and vehicle load optimization with environmental implications associated with assets deployed
 - Investigate alternate solutions with expanded analytical data
- **COMPASS + MIQ**
 - Combine LCA with hazard screens for materials to allow a holistic view
 - Develop a lower cost entry into risk assessment for product development

discussion

- Limitations
 - Current and representative life cycle inventory (LCI)
 - Data transparency and uncertainty
 - Methodologies
- Drivers
 - Retailer and corporate scorecards
 - Global Packaging Protocol for Sustainability (GPPS)
 - The Sustainability Consortium (TSC)
 - GS1 Global Data Standard
- Opportunities
 - Measurements \neq Sustainability
 - Use LCA to improve environmental performance of package and product, DfE and/or DfR, not for making claims
 - Informing public policy

Thank you!

Minal T. Mistry

Sr. Manager of Sustainability Solutions

minal@greenblue.org